



 **trimax**[™] // **POWERING PERFORMANCE.**
MOWING SYSTEMS

PRODUCT CATALOG.

★★★
INDUSTRY LEADING WARRANTY

3
YEAR

INCLUDES SPINDLES & GEARBOXES
EXPERIENCED SERVICE & SUPPORT NETWORK



EQUIPMENT THAT POWERS PERFORMANCE.

From humble beginnings in New Zealand, to a world leader in Commercial Mowing - our success is driven by a passion to help customers find a better way.

We listen to how you use our products, designing with customer focused innovation to solve problems you encounter. The result? Mowing solutions which increase productivity, reduce maintenance and can be relied on day-after-day for years of full time commercial use.



**LONG
COMMERCIAL LIFE.**



**LOW TOTAL-COST-
OF-OWNERSHIP.**



**EASE OF
MAINTENANCE.**



**INTUITIVE
TO USE.**



**INDUSTRY LEADING
CUT PRESENTATION.**



**SERVICE THAT EXCEEDS
EXPECTATIONS.**

EQUIPMENT SHOULD NEVER BE A BARRIER TO SUCCESS.

- BOB SIEVWRIGHT / FOUNDER & OWNER

Founded in New Zealand in 1981, Trimax has grown from a modest workshop into a global business with facilities around the world. Today many of our mowers destined for United States turf are assembled or manufactured locally at our factory in Fayetteville, Georgia. Our global headquarters is still located where we began in Tauranga, New Zealand.

We are renowned for designing and manufacturing mowing systems which produce a high-quality cut, finish, and spread - but what we value most is the reputation we have earned for providing unmatched local support and service.





DISTRIBUTED FROM OUR
USA
WAREHOUSE

OUR APPROACH TO INNOVATION IS DRIVEN BY YOU. WITH A FOCUS ON CREATING SOLUTIONS TO YOUR CHALLENGES, TOGETHER, WE'RE ABLE TO RAISE THE BAR ON RESULTS.



- BOB SIEVWRIGHT
TRIMAX MOWING SYSTEMS
OWNER/FOUNDER



- MICHAEL SIEVWRIGHT
TRIMAX MOWING SYSTEMS
CEO

ROTARY MOWERS.



STRIKER



PROCUT/S4



STEALTH/S3



SNAKE/S2



PEGASUS/S5



X-WAM



VULCAN

FLAIL MOWERS.



FLAILDEK/FX



EZEEMOW/FX



WARLORD/S3

TRIMAX STRIKER

FAST BECOMING THE MOWER OF CHOICE AMONGST GROUNDSMEN.

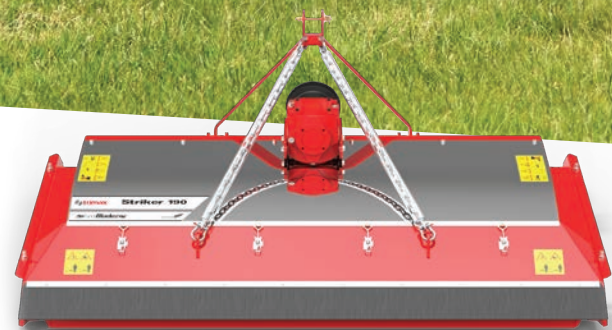

TRIMAX STRIKER

Trimax STRIKER is a multi-spindled rotary mower with extremely low maintenance requirements and is ideal for use on compact tractors.

The Trimax Striker is designed to give a high cut quality and an excellent spread of clippings. Highly versatile, the Striker is capable of mowing grass $\frac{3}{8}$ " - 4". With an enclosed cutting chamber and a downward rear dispersion of clippings, the Striker has surpassed international safety standards making it one of the safest mowers on the market for use in public spaces.

Fitted with Trimax's exclusive LazerBladez™, the Striker can produce a cut and finish to rival that of a reel mower and is ideal for educational and sports facilities where presentation is key!

TALK TO US TODAY ABOUT THE CAPABILITIES OF STRIKER IN YOUR ENVIRONMENT.



SPECIFICATIONS	150	190
Cutting Width	4' 9 1/2" (1.46m)	6' 4 1/2" (1.96m)
Overall Width	5' 1 1/2" (1.56m)	6' 8 1/2" (2.04m)
Overall Length	3' 9 1/2" (1.16m)	3' 9 1/2" (1.16m)
Height	2' 8" (0.83m)	2' 8" (0.83m)
Cut Height Range	3/8" - 4" (10 - 100mm)	3/8" - 4" (10 - 100mm)
No. of Blade Spindles	3	4
Approx. Weight	710lbs (322kg)	882lbs (400kg)
Min PTO Output	25hp	30hp

*Minimum PTO output is a guide only. Requirement varies with the type of work and the terrain



What used to take half a day now takes less than an hour, we can mow when the grass is wet, it doesn't scalp and we can stripe the fields. It's very impressive!
- PAUL CHEETHAM | Immanuel Lutheran College, Sunshine Coast QLD, AUS

KEY APPLICATIONS.

- ✓ Sports fields & pitches
- ✓ Golf Courses
- ✓ Country Clubs
- ✓ Estates & Lifestyle Blocks
- ✓ Schools

WHAT'S NEW ON STRIKER

The Striker was originally designed as a compact solution for sports turf, especially for grounds maintenance for local football and cricket clubs. It features a simpler pan construction than the ProCut and includes maintenance-free ball bearing spindles.

INDUSTRY LEADING WARRANTY

3
YEAR

INCLUDES SPINDLES & GEARBOXES
EXPERIENCED SERVICE & SUPPORT NETWORK



PRODUCT FEATURES.



LOW COST OF OWNERSHIP
With only 4 grease points on the mower and with robust sealed spindles, the Trimax Striker has incredibly low maintenance requirements.



LAZERBLADEZ™
Available in up lift and flat formation to suit mowing requirements, the unique tilt forward design minimizes hang back in tough conditions.



STRIPING CAPABLE
Fitted with full width front and rear rollers, the Striker can produce striped patterned turf for those spaces where presentation is key.



SAFETY FOR PUBLIC PLACES
Striker exceeds international safety standards, and can be used with confidence in public spaces, school sports turf and confined areas.



ADVANCED ENGINEERING
Trimax's meticulous design process combined with bespoke, innovative manufacturing technologies produce the most accurate rotary cutting in the market.



COMPACT TRACTOR SUITABLE
Able to be paired with tractors as low as 20hp, the Striker is perfect for smaller budgets and compact tractors.

*OPTIONAL FEATURES.

- ✓ **ROLLER SCRAPERS**
Cleans rollers and reduces clumping in wet conditions.
- ✓ **NEXABLADES**
Scientifically designed for high-end turf giving a superior cut and spread when it matters most.
- ✓ **ON-CALL KIT**
Each kit contains bearings, blades, and belts for a quick replacement in the field.

VIEW MORE PHOTOS, VIDEOS, AND INFORMATION ABOUT THE TRIMAX STRIKER ONLINE HERE:



TRIMAX PROCUT/S4



**ENGINEERED TO WITHSTAND
EVERYDAY USE IN THE
TOUGHEST COMMERCIAL
ENVIRONMENTS.**

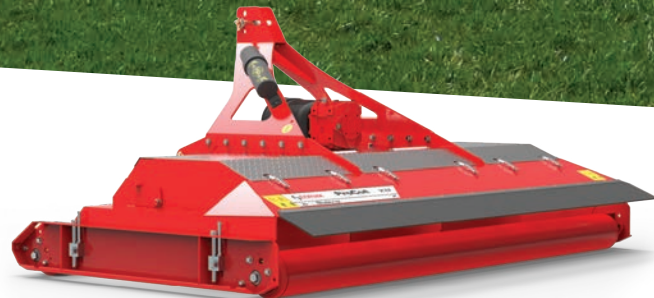

TRIMAX PROCUT/S4

A highly versatile roller mower, the PROCUT SERIES 4 is a multi-spindled roller mower designed to give high cut quality and a great spread of clippings.

The ProCut has been a successful part of the Trimax range for over 40 years, mowing parks and reserves, school grounds and sports turf around the world – from the grounds of Windsor Castle to your local community sports turf.

The ProCut Series 4, released in 2018, is excellence refined. Now even easier to operate and maintain than ever before, the ProCut still retains many of the aspects that propelled it to become one of the best sports mowers on the market.



SPECIFICATIONS	178	210	237	290
Cutting Width	5' 8 1/2" (1.74m)	6' 9" (2.06m)	7' 7" (2.32m)	9' 6" (2.89m)
Overall Width	6' 2" (1.88m)	7' 3" (2.2m)	8' 1" (2.46m)	10' 3" (3.13m)
Overall Length	4' 5" (1.34m)	4' 5" (1.34m)	4' 5" (1.34m)	4' 5" (1.34m)
Height	3' 7" (1.09m)	3' 7" (1.09m)	3' 7" (1.09m)	3' 7" (1.09m)
Cut Height Range	3/8" - 4" (10 - 100mm)	3/8" - 4" (10 - 100mm)	3/8" - 4" (10 - 100mm)	3/8" - 4" (10 - 100mm)
No. of Blade Spindles	3	3	4	5
Approx. Weight	1126lbs (511kg)	1340lbs (608kg)	1413lbs (641kg)	1697lbs (770kg)
Min PTO Output	35hp	40hp	45hp	55hp

**Minimum PTO output is a guide only. Requirement varies with the type of work and the terrain*



The ProCut is the best mower I've ever had... it mows my polo field to perfection.
-CHRISTOPH GERBERDING Polo Grounds, Milford, New Jersey

KEY APPLICATIONS.

- ✓ Municipality ✓ Horticulture ✓ Golf Courses ✓ School ✓ Lifestyle ✓ Sports Turf
- ✓ Aviation ✓ Sod Farm ✓ Racecourse ✓ Polo

WHAT'S NEW ON PROCUT S4

Maintaining your mower has never been easier with the introduction of several new features including stand-on covers, dual wash ports, and the Trimax LocTek roller bearing retention system, which contribute to faster and safer regular servicing.

PRODUCT FEATURES.



LOCTEK

A stubless roller bearing system for vastly improved roller retention, alignment, bearing life and minimal maintenance.



STEADFAST SEALED SPINDLES

We've eliminated the tedious task of regular greasing. Covered by our 3-year warranty, maintenance costs are reduced, and productivity is enhanced.



LAZERBLADEZ™

Available in uplift and flat formation to suit mowing requirements, the unique tilt forward design minimizes hang back in tough conditions.

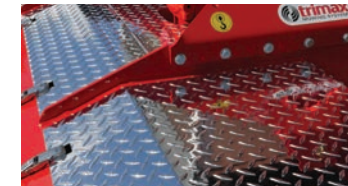

STAND ON COVERS

Enables safe and easy access to the rear of the tractor when coupling the mower. Quick release latches allow easy removal for cleaning and servicing.



BELT CAVITY DUAL WASH FLAPS

Provides easy access for removal of grass and drainage of water from belt chamber.



RAPIDSET HEIGHT ADJUSTMENT

Clearly displayed stainless steel height indicators allow the easy adjustment of cut heights without having to raise or lower the deck.



FULL WIDTH ROLLERS

Full width rollers minimize scalping in undulating conditions and allow mowing over curbs and bunkers. Also aids in striping.



ADVANCED ENGINEERING

Trimax's meticulous design process combined with bespoke, innovative manufacturing technologies produce the most accurate rotary cut in the market.



*OPTIONAL FEATURES.

- ✓ **ROLLER SCRAPERS**
Cleans rollers and reduces clumping in wet conditions.
- ✓ **ANTI-BOUNCE / WEAR SKIDS**
Eliminates scalping and bouncing and reduces side channel wear.
- ✓ **QUATTRO BLADES**
Four blades (flat, upturned or mixed) per spindle for a finer cut.
- ✓ **GALVANIZED SURFACE COATING**
Protect against corrosion in harsh environments.
- ✓ **LIGHTING KIT WITH STORAGE BRACKET**
LED road lights, safety triangle, and bracket for storage box.
- ✓ **STORAGE BOX**
Easy access to spare parts and tools.
- ✓ **NEXABLADES**
Scientifically designed for high-end turf giving a superior cut and spread when it matters most.
- ✓ **ON-CALL KIT**
Each kit contains bearings, blades, and belts for a quick replacement in the field.

TALK TO US TODAY ABOUT THE CAPABILITIES OF PROCUT SERIES 4 IN YOUR ENVIRONMENT.

VIEW MORE PHOTOS, VIDEOS, AND INFORMATION ABOUT THE TRIMAX PROCUT SERIES 4 ONLINE HERE:



TRIMAX STEALTH/S3



**MARKET LEADING
CUT, FINISH AND
VERSATILITY.**



TRIMAX STEALTH/S3

The STEALTH SERIES 3 has been designed to give a higher quality of cut, operate in a wider range of conditions, be safer, more robust, easier to operate and take less time to maintain than any previous STEALTH.

Backed by over 30 years' of experience in market, the concept of Stealth Series 3 was born from the demand of our Australian customers for a mower that was more versatile in terms of long grass performance and more user friendly for both the operator and the workshop.

Backed by our industry leading 3-year warranty and our parts and technical support team, we know the Stealth Series 3 to be the best linkage wing mower for passive and active turf in the market.

**TALK TO US TODAY ABOUT THE CAPABILITIES
OF STEALTH SERIES 3 IN YOUR ENVIRONMENT.**



SPECIFICATIONS

	340
Cutting Width	11' 2" (3.4m)
Overall Width	11' 8" (3.55m)
Transport Width	7' 11" (2.42m)
Overall Length	5' 4" (1.63m)
Height	3' 11 1/2" (1.21m)
Cut Height Range	3/8" - 3 1/2" (10 - 90mm)
No. of Blade Spindles	5
Approx. Weight	2070lb (940kg)
Min PTO Output	70hp

*Minimum PTO output is a guide only. Requirement varies with the type of work and the terrain



"We're mowing 7 hours a day and getting large areas done quickly. It's easily maneuverable and the contouring following ability of the wings and the ability to fold up them up with an in-cab transport lock is a huge advantage."

- JOHN ROSNELL - Springbrook Wholesale Nursery, Gold Coast QLD

KEY APPLICATIONS.

- ✓ Municipalities
- ✓ Parks & Reserves
- ✓ Estates & Lifestyle Blocks
- ✓ Racecourses
- ✓ Sports Fields
- ✓ Horticulture
- ✓ Aviation

WHAT'S NEW ON STEALTH/S3

We've reduced the need for greasing through the introduction of new features such as SteadFast maintenance-free spindles and composite maintenance-free bushes. Stealth wing locks can now be operated from inside the tractor cab. Modifications have been made to the cutting chamber and the baffle design for improved cut quality and easy cleaning.

INDUSTRY LEADING
WARRANTY

3
YEAR

INCLUDES SPINDLES
& GEARBOXES
EXPERIENCED SERVICE
& SUPPORT NETWORK

PRODUCT FEATURES.



LOCTEK

A stubless roller bearing system for vastly improved roller retention, alignment, bearing life and minimal maintenance.



LOW MAINTENANCE

Operators are no longer required to grease hinge points and spindles on a daily basis and can spend more time mowing and less time on maintenance.



LAZERBLADEZ™

Available in uplift and flat formation to suit mowing requirements, the unique tilt forward design minimizes hang back in tough conditions.



GREATER MOWING VERSATILITY

The improved cutting chamber and baffle design directs airflow from the blades out and over the rear roller for a better cut and spread.



EASY TO CLEAN

The improved belt chamber design results in easy cleaning, with the front openings allowing any grass to be easily washed out or removed.



EASY HEIGHT ADJUSTMENT

Clearly displayed stainless steel height indicators allow the easy adjustment of cut heights without having to raise or lower the wings or deck.



IN-CAB UNLOCK SYSTEM

Unlock the mower wings' transport lock from the convenience of the tractor seat using the tractor's hydraulic control lever.



ANTI-WEAR SKIDS

Anti-wear skids reduce wear on side channels when operating in rough or uneven terrain.



STAND ON COVERS

Enables safe and easy access to the rear of the tractor when coupling to the mower. Quick release latches allow easy removal for cleaning and servicing.

*OPTIONAL FEATURES.

✓ ROLLER SCRAPERS

Cleans rollers and reduces clumping in wet conditions.

✓ ON-CALL KIT

Each kit contains bearings, blades, and belts for a quick replacement in the field.

**VIEW MORE PHOTOS, VIDEOS, AND INFORMATION
ABOUT THE TRIMAX STEALTH SERIES 3 ONLINE HERE:**



TRIMAX SNAKE S2



**WORLD CLASS
CUT QUALITY AND
ARTICULATION.**

TRIMAX SNAKE S2

The Trimax SNAKE is used on some of the most prestigious golf courses around the world. The cutting system has been studied by the Sports Turf Institute of New Zealand and declared to produce a cut of equal quality to reel mowers however with the versatility and reliability of our famous rotary design.

An accumulation of over 30 years of Trimax innovation, engineering, and customer insight, the Snake is the original roller mower designed specifically for sports turf and golf courses. We've seamlessly combined our world class cut quality and articulation capabilities and believe we've created the best sports turf rotary mower in the world. Built for agility, incredibly robust and extremely low maintenance, the Trimax Snake won't fail to impress.

TALK TO US TODAY ABOUT THE CAPABILITIES OF SNAKE SERIES 2 IN YOUR ENVIRONMENT.



SPECIFICATIONS	320	400
Cutting Width	10' 7" (3.23m)	13' 1" (3.99m)
Overall Width	11' 1" (3.37m)	13' 6" (4.11m)
Overall Length	11' 6" (3.5m)	11' 6" (3.5m)
Transport Width	6' 10 1/2" (2.1m)	7' 3/4" (2.14m)
Transport Height	5' 11 1/2" (1.82m)	7' 3 1/2" (2.21m)
Cut Height Range	3/8" - 4" (10 - 100mm)	3/8" - 4" (10 - 100mm)
No. of Blade Spindles	9	11
Approx. Weight	2756lbs (1250kg)	3064lbs (1390kg)
Min PTO Output	35hp	45hp

*Minimum PTO output is a guide only. Requirement varies with the type of work and the terrain

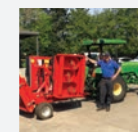

Between the ease of height adjustment to the ease of maintenance and greasing and the minimal bearings and belts that have to be maintained - it's a great piece of equipment.

- WES HOLSENBECK | Equipment Manager, East Lake Golf Club, Atlanta

KEY APPLICATIONS.

- ✓ Golf Courses (Roughs & Fairways)
- ✓ Sports Fields
- ✓ Turf / Sod Farms
- ✓ Municipalities
- ✓ Schools
- ✓ Large Estates & Country Clubs

WHAT'S NEW ON SNAKE S2

The Snake Series 2 includes the new Trimax LocTEK stubless roller bearing retention system. The roller thickness has been increased to 5mm. The Snake now features replaceable axle stubs, a 90-degree rotatable jack stand, and maintenance-free pivot bushes.

PRODUCT FEATURES.



LOCTEK

A stubless roller bearing system for vastly improved roller retention, alignment, bearing life and minimal maintenance.



FULL WIDTH ROLLERS

Full width rollers minimize scalping in undulating conditions and allow mowing over curbs and bunkers. Also aides in striping.

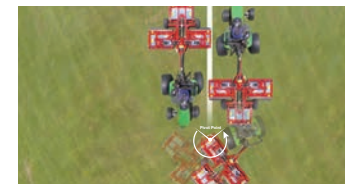

ZERO TURN

Allows continuous cutting while turning sharply for maximum productivity.



AUTOMATIC BELT TENSIONERS

Automatic belt tensioners eliminate the need for belt adjustments and improves drive to the spindles and blades.



QUIKLIFT

QuikLIFT enables decks to be raised slightly for traversing paths without the need to disengage the PTO. Also aides in striping.



ARTICULATION ABILITY

With three articulating decks the Snake has the ability to follow contours.



LAZERBLADEZ™

Available in uplift and flat formation to suit mowing requirements, the unique tilt forward design minimizes hang back in tough conditions.

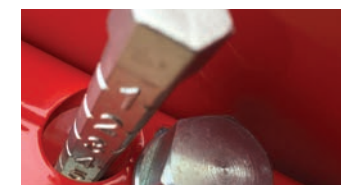

EASY HEIGHT ADJUSTMENT

Clearly displayed stainless steel height indicators allow the easy adjustment of cut heights without having to raise or lower the decks.



LOW MAINTENANCE

SteadFast sealed spindles have eliminated the tedious task of regular greasing. Snake Series 2 now also features maintenance free pivot bushes.

INDUSTRY LEADING
WARRANTY

3

YEAR

INCLUDES SPINDLES & GEARBOXES

EXPERIENCED SERVICE & SUPPORT NETWORK

*OPTIONAL FEATURES.

✓ ROLLER SCRAPERS

Cleans rollers and reduces clumping in wet conditions.

✓ MULCH KIT

Save on purchasing dedicated leaf blowing and collection units with the Snake Mulch Kit. Retrofittable to existing Snake S1 & S2 models.

✓ MUDGUARDS, LIGHTS, & CHAINS

Add LED tail light clusters, safety chains, and transport wheel mudguards for increased safety during road transportation.

✓ ELECTRIC UNLOCK

Replaces the standard in-cab transport lock release rope with an electric actuator. This is operated by a push button remote.

✓ ANTI-BOUNCE / WEAR SKIDS

Eliminates scalping and bouncing and reduces side channel wear.

✓ NEXABLADES

Scientifically designed for high-end turf giving a superior cut and spread when it matters most.

✓ ON-CALL KIT

Each kit contains bearings, blades, and belts for a quick replacement in the field.

VIEW MORE PHOTOS, VIDEOS, AND INFORMATION ABOUT THE TRIMAX SNAKE SERIES 2 ONLINE HERE:



TRIMAX PEGASUS//S5



**STRONGER.
SMARTER.
SAFER.
SECOND TO NONE.**

TRIMAX PEGASUS//S5

The Trimax Pegasus sets the benchmark in wide area mowing for parks, reserves, airports, racecourses, sports fields, turf farms, and more.

For over 20 years, the Trimax Pegasus has been leading the way in wide-area mowing. Introduced in 2001 as the world's first multi-deck roller mower, the Pegasus is renowned for its robustness and versatility. Its fast spindle speeds and deep mowing decks deliver the highest quality cut and finish every time, and articulating decks provide a consistent cut over light to moderate contours.

The Pegasus S5 builds on the incredible strength, durability, versatility, and efficiency of the previous series to increase machine life and decrease downtime in full-time commercial applications.



SPECIFICATIONS	493	610	722
Cutting Width	16' 2" (4.94m)	19' 11" (6.09m)	23' 9" (7.23m)
Overall Width	16' 9" (5.1m)	20' 6" (6.24m)	24' 3" (7.39m)
Overall Length	15' 3" (4.65m)	15' 3" (4.65m)	15' 3" (4.65m)
Transport Width	8' 3 3/4" (2.53m)	8' 3 3/4" (2.53m)	8' 3 3/4" (2.53m)
Transport Height	8' 7" (2.62m)	10' 6" (3.2m)	12' 6" (3.8m)
Cut Height Range	3/8" - 4 1/2" (10 - 110mm)	3/8" - 4 1/2" (10 - 110mm)	3/8" - 4 1/2" (10 - 110mm)
No. of Blade Spindles	9	11	13
Approx. Weight	4895lbs (2200kg)	5380lbs (2440kg)	5865lbs (2660kg)
Min PTO Output	50 hp	55 hp	60 hp

*Minimum PTO output is a guide only. Requirement varies with the type of work and the terrain

KEY APPLICATIONS.

- ✓ Turf / Sod Farm
- ✓ Parks & Reserves
- ✓ Racecourses, Polo, & Sports Turf
- ✓ Aviation
- ✓ Large Estates

WHAT'S NEW ON PEGASUS S5

The Pegasus chassis and outrigger arms have been completely redesigned to increase strength without adding unnecessary weight. Larger wheels decrease ground pressure and support a wider range of tyre options. Maintenance-free features have been introduced.

PRODUCT FEATURES.



ROBUST CHASSIS
10% stronger under tough travel conditions, twice the durability in deck lifting and lowering, and a 60% increase in rigidity in the outrigger arms from Pegasus S4.



LOW MAINTENANCE
Zero daily greasing for an 80% reduction in annual grease consumption. Spindles, roller bearings, and auto-belt tensioning are maintenance-free.



QUIKLIFT
Enables mower decks to be raised without disengaging the PTO to traverse driveways, footpaths and pavements. Now a standard inclusion for all Pegasus models.



STAND ON BELT COVERS
Provides safe and easy access to the chassis.



IMPACT PROTECTION
Outrigger arms and side channel leading edges have been redesigned for increased impact protection.



AUTO BELT TENSIONING
Improves drive to the spindles without requiring manual belt adjustments.



TITAN ROLLER BEARING SYSTEM
The Trimax Titan roller bearing system is maintenance-free, requiring no regular greasing, and provides excellent retention.



SUSPENSION
The new Pegasus S5 Torque Suspension System is designed for increased strength and smoother travel at highway speeds.



HEIGHT ADJUSTMENT
Clearly displayed indicators in both metric and imperial units and a high-tensile 2mm pitch adjuster for precise cut height alterations.



SAFETY COMPLIANT
Complies with international safety standards and can be used with confidence on the roads and in public spaces.

*OPTIONAL FEATURES.

- ✓ **ANTI-BOUNCE / WEAR SKIDS**
Eliminates scalping and bouncing and reduces side channel wear.
- ✓ **ROLLER SCRAPERS**
Cleans rollers and reduces clumping in wet conditions.
- ✓ **NEXABLADES**
Scientifically designed for high-end turf giving a superior cut and spread when it matters most.
- ✓ **QUATTRO BLADE SYSTEM**
Four blades (flat, upturned or mixed) per spindle for a finer cut.
- ✓ **ELECTRIC UNLOCK**
Unlocks decks electronically from the tractor seat.
- ✓ **TURF TIRES**
Distributes mower weight for less ground disturbance.
- ✓ **SPARE ROAD TIRE & MOUNT**
Mounts a spare wheel to the rear mowing deck.
- ✓ **STORAGE KIT**
Mounts a toolbox to the mower chassis.
- ✓ **GALVANIZED SURFACE COATING**
Protect against corrosion in harsh environments.
- ✓ **ROAD KIT**
Adds lights, signage, and beacons to the mower.
- ✓ **TURF MUDGUARDS**
Available for both road tires and turf tires.
- ✓ **ON-CALL KIT**
Each kit contains bearings, blades, and belts for a quick replacement in the field.

TALK TO US TODAY ABOUT THE CAPABILITIES OF PEGASUS SERIES 5 IN YOUR ENVIRONMENT.

VIEW MORE PHOTOS, VIDEOS, AND INFORMATION ABOUT THE TRIMAX PEGASUS SERIES 5 ONLINE HERE:



TRIMAX X-WAM



**THE ULTIMATE IN WIDE
AREA MOWING WHEN
QUALITY COUNTS.**



TRIMAX X-WAM

The X-WAM has superior contour-following abilities based on the unique combination of five individual floating decks on an articulated axis.

With the potential to cut 32 acres per hour and the ability to perform zero-turns without having to lift any of the mower decks, the X-WAM will increase your productivity and efficiency using only one tractor, one driver, and one mower.

Providing an even discharge of clippings and with the ability to mow in wet conditions and produce a reel-like patterned finish, X-WAM is the ultimate wide area mower.



SPECIFICATIONS	1040
Cutting Width	34' 2" (10.41m)
Overall Width	34' 7" (10.54m)
Overall Length	19' 1" (5.83m)
Transport Width	9' (2.74m)
Transport Height	14' 7" (4.45m)
Cut Height Range	3/8" - 4" (10 - 100mm)
No. of Blade Spindles	19
Approx. Weight	10,759lbs (4880kg)
Min PTO Output	90 hp

*Minimum PTO output is a guide only. Requirement varies with the type of work and the terrain

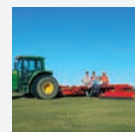

Trimax X-WAM is great equipment. It replaced one tractor, one employee and reduced mowing time. Less equipment to maintain and less equipment expense has increased our profitability.

- LYNN GIBB | Hope Plantation Turf, Texas USA

KEY APPLICATIONS.

✓ Turf / Sod Farm

WHAT'S NEW ON X-WAM

The X-WAM is Trimax's widest mower, with 5 full-sized mowing decks. It is available as a complete model or as a kit to add to the Trimax Pegasus 610. The decks can be retracted for transport.

PRODUCT FEATURES.



LOCTEK

A stubless roller bearing system for vastly improved roller retention, alignment, bearing life and minimal maintenance.



WHEELS RUN ON CUT GRASS

As the rear deck is located between the rear transport wheels, grass is not flattened by wheels prior to mowing, a feature unique to Trimax.



TURF TIRE

Trimax Turf Tires help distribute the weight of the mower for less ground disturbance. Recommended for sod and turf farms or fine turf applications.



FULL HYDRAULIC OPERATION

The X-WAM uses full hydraulic operation for deck retraction into road transport mode.



LOW MAINTENANCE

All moving surfaces have long life synthetic bushes or greasable bearings and remote grease points for hassle-free maintenance.



STEADFAST SEALED SPINDLES

We've eliminated the tedious task of regular greasing. Covered by our 3-year warranty, maintenance costs are reduced, and productivity is enhanced.



LAZERBLADEZ™

Available in up-lift and flat formation to suit mowing requirements, the unique tilt forward design minimises hang back in tough conditions.



RAPIDSET HEIGHT ADJUSTMENT

Clearly displayed stainless steel height indicators allow the easy adjustment of cut heights without having to raise or lower the wings.



ULTIMATE CONTOUR FOLLOWING

Contour following and cut quality is compromised when decks are over 9' 10" wide. The X-WAM features multiple smaller decks for superior cut quality.



GALVANIZED SURFACE COATING

Protect against corrosion in harsh environments.

*OPTIONAL FEATURES.

✓ ANTI-BOUNCE / WEAR SKIDS

Eliminates scalping and bouncing and reduces side channel wear.

✓ ROLLER SCRAPERS

Cleans rollers and reduces clumping in wet conditions.

✓ QUATTRO BLADES

Four blades (flat, upturned or mixed) per spindle for a finer cut.

✓ ELECTRIC UNLOCK

Replaces the standard in-cab transport lock release rope with an electric actuator. This is operated by a push button remote.

✓ NEXABLADES

Scientifically designed for high-end turf giving a superior cut and spread when it matters most.

✓ ON-CALL KIT

Each kit contains bearings, blades, and belts for a quick replacement in the field.

TALK TO US TODAY ABOUT THE CAPABILITIES OF X-WAM IN YOUR ENVIRONMENT.

VIEW MORE PHOTOS, VIDEOS, AND INFORMATION ABOUT THE TRIMAX X-WAM ONLINE HERE:



TRIMAX VULCAN



**DESIGNED TO GIVE YOU THE
ADVANTAGE OVER YOUR
COMPETITION.**



TRIMAX VULCAN

The Trimax VULCAN is the highest return on investment castor wheel mower in the market.

Designed with all the latest features and innovations Trimax has to offer, the Vulcan provides significant long term cost savings for sod and turf farms. Vulcan has been shown to consume 31% less PTO power, which corresponds to fuel savings of up to 14% when compared to the current industry leading castor wheel mower.

Subjected to extensive strength and durability testing during development, the Vulcan is incredibly robust, suitable for full-time commercial use and engineered for longevity of life – a feature Trimax mowing equipment is renowned for. The Vulcans almost 24' cut width paired with Trimax design standards and cut technologies make the Trimax Vulcan the most efficient caster wheel mower on the market!



SPECIFICATIONS	725
Cutting Width	23' 9" (7.25m)
Overall Width	23' 10" (7.28m)
Overall Length	20' (6.1m)
Transport Width	8' 1" (2.46m)
Transport Height	11' 8" (3.55m)
Cut Height Range	¾" - 5" (20 - 130mm)
No. of Blade Spindles	11
Approx. Weight	5666lbs (2550kg)
Min PTO Output	60 hp

*Minimum PTO output is a guide only. Requirement varies with the type of work and the terrain

KEY APPLICATIONS.

✓ Turf / Sod Farm

WHAT'S NEW ON VULCAN

The Vulcan is up to 14% more fuel efficient than competitor mowers, with three floating decks supported by puncture-proof offset castor wheels. The Vulcan has less steel-on-steel wear than comparable castor wheel mowers and has a proven and simple belt drive



PRODUCT FEATURES.



PUNCTURE PROOF SOLID TIRES
These solid closed cell, airless formulated tires do not absorb water allowing superior rolling performance, durability, and no punctures.



GALVANISED SURFACE COATING
Provides added protection against corrosion in coastal environments with high salt concentrations or high fertiliser usage.



EASILY TRANSPORTABLE
Compacts to 8' wide for easy transport from farm to farm (refer to local road regulations).



STAND ON COVERS
Aluminium treadplates make up the heavy duty covers that guard the belt chamber.



STEADFAST SEALED SPINDLES
We've eliminated the tedious task of spindle greasing. Covered by our 3-year warranty, maintenance costs are reduced, and productivity is enhanced.



AUTOMATIC BELT TENSIONERS
Automatic belt tensioners eliminate the need for belt adjustments and improves drive to the spindles and blades.



QUICK & EASY HEIGHT ADJUSTMENT
Spacer rings are used to set the height and ergonomically designed handles make it simple for a one-person change in under 15 minutes.



TURF TIRES
Trimax Turf tires help distribute the weight of the mower for less ground disturbance.



SAFETY TESTED
The Vulcan complies with agricultural standard ISO4254 for protection against thrown objects, blade impact, blade unbalance and more.



LAZERBLADEZ™
Available in uplift and flat formation to suit mowing requirements, the unique tilt forward design minimizes hang back in tough conditions.



ADJUSTABLE DRAWBAR
Align the drawbar with the tractor hitch while maintaining a level chassis with one simple adjustment.

*OPTIONAL FEATURES.

- ✓ **NEXABLADES**
Scientifically designed for high-end turf giving a superior cut and spread when it matters most.
- ✓ **ON-CALL KIT**
Each kit contains bearings, blades, and belts for a quick replacement in the field.

TALK TO US TODAY ABOUT THE CAPABILITIES OF VULCAN IN YOUR ENVIRONMENT.

VIEW MORE PHOTOS, VIDEOS, AND INFORMATION ABOUT THE TRIMAX VULCAN ONLINE HERE:



TRIMAX

FLAILDEK FX



**TRIMAX FLAIL
TECHNOLOGY
FOR OUT FRONT
OPERATION.**



TRIMAX FLAILDEK FX

The Trimax FlailDek FX offers a high-performance alternative to standard factory-fitted rotary mowing attachments.

FlailDek FX has the ability to deliver an exceptionally clean cut and disperse clippings safely and is used by contractors, councils, schools and land owners around the world. A highly versatile mower, FlailDek FX is also able to mulch branches up to 1 inch in diameter, mow high grass and using the unique converter flap is suitable for sports turf and other fine turf applications.

The FlailDek FX has been designed to have minimal maintenance requirements and a low total cost of ownership yet deliver maximum reliability.



SPECIFICATIONS	135	155	185
Cutting Width	4' 6" (1.36m)	5' (1.52m)	6' (1.83m)
Overall Width	5' 1 1/2" (1.56m)	5' 8" (1.72m)	6' 8 1/2" (2.05m)
Overall Length	3' 7" (1.1m)	3' 7" (1.1m)	3' 7" (1.1m)
Overall Height	1' 2 1/2" (0.37m)	1' 2 1/2" (0.37m)	1' 2 1/2" (0.37m)
Cut Height Range	3/4" - 4" (20 - 100mm)	3/4" - 4" (20 - 100mm)	3/4" - 4" (20 - 100mm)
Approx. Weight	460lbs (210kg)	495lbs (225kg)	550lbs (250kg)
Total Belts	2	2	2
No. of Flails	28	32	40
Min PTO Output	N/A	N/A	N/A

*Minimum PTO output vary between tractor brands



This year I could not have coped without anything other than a Trimax FlailDek, it's versatile, cuts rough and fine grass even in the wet conditions and copes with it easily.

- ANDREW HALL | Truelink Ltd

KEY APPLICATIONS.

- ✓ Horticulture
- ✓ Municipalities
- ✓ Golf course roughs
- ✓ Racecourses
- ✓ Sports Fields
- ✓ Schools
- ✓ Aviation

WHAT'S NEW ON FLAILDEK FX

Strength and durability are increased from the original FlailDek design with the incorporation of a high tensile steel body, a 70% stronger rotor, a stronger gearbox, and forged steel Trimax Gamma Flails. The unique converter has also been added.

INDUSTRY LEADING WARRANTY

3
YEAR

INCLUDES SPINDLES & GEARBOXES
EXPERIENCED SERVICE & SUPPORT NETWORK



PRODUCT FEATURES.



UNIQUE CONVERTER

Superb short grass cutting ability by creating airflow that lifts grass before it's cut. Open converter for increased productivity in long grass environments.



REAR ROLLER

Full width rear roller prevents scalping, permits the edge of the mower to be run along curbs, adds to overall safety and produces striping.



POWER SAVING FLAILS

Strong forged steel flail with an aerodynamic profile reduces hp requirements yet generates sufficient draft to lift grass for a clean cut.



NEW IMPROVED ROTOR

Dynamically balanced and designed for durability to withstand everyday use in the toughest mowing environments.



SAFE CLIPPING DISPERSION

Safety is paramount when mowing in public areas. This is why Trimax has designed the FlailDek FX to expel debris in a downward direction behind the mower.



FRONT CASTOR WHEELS

Front castor wheels allow the FlailDek FX to follow ground contours independently from the tractor. The semi-pneumatic tires are impossible to puncture.



WEAR RESISTANT SKIDS

Wear resistant trailing skids made from abrasion-resistant steel extends bearing life and enables high productivity in the most challenging environments.

TALK TO US TODAY ABOUT THE CAPABILITIES OF FLAILDEK FX IN YOUR ENVIRONMENT.

VIEW MORE PHOTOS, VIDEOS, AND INFORMATION ABOUT THE TRIMAX FLAILDEK FX ONLINE HERE:



TRIMAX EZEEMOW/FX



**TRIMAX FLAIL
TECHNOLOGY FOR
COMPACT TRACTORS.**

TRIMAX EZEEMOW/FX

The EZEEMOW FX is the ideal partner for your compact tractor where versatility and robustness is needed.

With its compact dimension, Ezeemow FX can fit closely to the tractor and manoeuvre into tight corners. Able to mow anything from fine turf to small prunings, vegetation up to 25mm in diameter and high grass, the Ezeemow FX can transform areas into tidy mown lawn in a single pass. This versatility makes the Ezeemow FX ideal for contractors, councils, roadsides, estates, and orchard applications.

The Ezeemow FX has been designed to have minimal maintenance requirements and low total cost of ownership yet deliver maximum reliability.



SPECIFICATIONS	135	155	185
Cutting Width	4' 6" (1.36m)	5' (1.52m)	6' (1.83m)
Overall Width	5' 1 1/2" (1.56m)	5' 8" (1.72m)	6' 8 1/2" (2.05m)
Overall Length	3' 7" (1.1m)	3' 7" (1.1m)	3' 7" (1.1m)
Overall Height	1' 2 1/2" (0.37m)	1' 2 1/2" (0.37m)	1' 2 1/2" (0.37m)
Cut Height Range	3/8" - 4" (10 - 100mm)	3/8" - 4" (10 - 100mm)	3/8" - 4" (10 - 100mm)
Approx. Weight	436lbs (198kg)	503lbs (228kg)	540lbs (245kg)
Total Belts	2	2	2
No. of Flails	28	32	40
Min PTO Output	17hp	20hp	24hp

**Minimum PTO output is a guide only. Requirement varies with the type of work and the terrain*



"I've been mowing 30hrs a week for over 28 years and my Ezeemow still has the same gearbox. It produces a beautiful cut and if I had to, I'd replace it with the exact same model...no two ways about it!"

- STEVE DE BRUIN | Grass Cutting Services, Tauranga NZ

KEY APPLICATIONS.

✓ Estates & Lifestyle Blocks ✓ Orchards & Vineyards ✓ Horticulture ✓ Municipalities ✓ Horse Agistment

WHAT'S NEW ON EZEEMOW/FX

Strength and durability are increased from the original Ezeemow design with the incorporation of a high tensile steel body, a 70% stronger rotor, a stronger gearbox, and forged steel Trimax Gamma Flails. The unique converter, an improved belt tensioning system, and easy height adjustment on the full width roller have also been added.

PRODUCT FEATURES.



UNIQUE CONVERTER

Superb short grass cutting ability by creating airflow that lifts grass before it's cut. Open converter for increased productivity in long grass environments.



NEW IMPROVED ROTOR

Dynamically balanced and designed for durability to withstand everyday use in the toughest mowing environments.



POWER SAVING FLAILS

Strong forged steel flail with an aerodynamic profile reduces hp requirements yet generates sufficient draft to lift grass for a clean cut.



REAR ROLLER

Full width rear roller prevents scalping, permits the edge of the mower to be run along curbs, adds to overall safety and produces striping.



SAFE CLIPPING DISPERSION

Safety is paramount when mowing in public areas. This is why Trimax has designed the Ezeemow FX to expel debris in a downward direction behind the mower.

EZEEMOW OFFSET DIAGRAM

ONLY AVAILABLE IN FIXED CENTRE MOUNT OR OFFSET POSITIONS

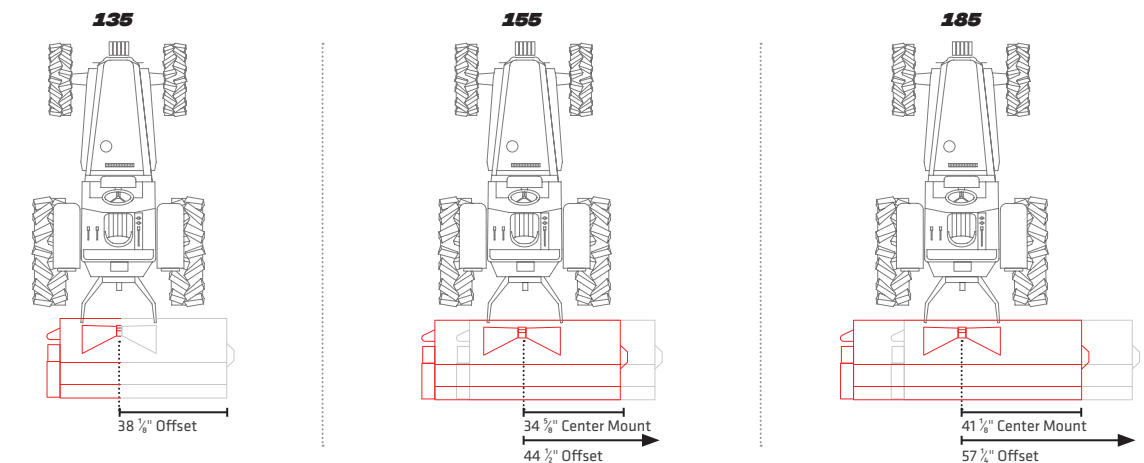

*OPTIONAL FEATURES.

✓ RIGHT-HAND OFFSET

Available in offset or center mount to suit your specific mowing requirements. See diagram below.

INDUSTRY LEADING WARRANTY

3
YEAR

INCLUDES SPINDLES & GEARBOXES
EXPERIENCED SERVICE & SUPPORT NETWORK

TALK TO US TODAY ABOUT THE CAPABILITIES OF EZEEMOW FX IN YOUR ENVIRONMENT.

VIEW MORE PHOTOS, VIDEOS, AND INFORMATION ABOUT THE TRIMAX EZEEMOW FX ONLINE HERE:



TRIMAX WARLORD S3

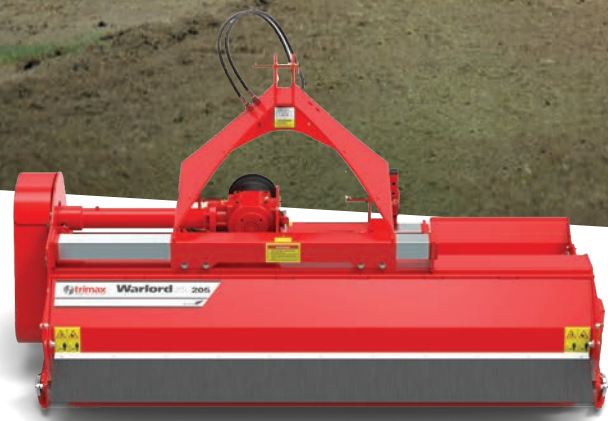

HEAVY DUTY FLAIL MULCHER MOWER.

TRIMAX WARLORD S3

The all new WARLORD S3 with its hydraulic sideshift operation makes for a powerful working companion in commercial applications.

We've designed the Warlord Series 3 to be safe and reliable for roadside and contracting work and have maintained our robust build which makes the Warlord the flail mower of choice for hire fleets.

With the ability to shred branches up to 3 inches in diameter and fitted with unique features such as a replaceable internal liner, pruning guide and an adjustable rear flap for servicing ease, the Warlord is a serious commercial flail mower.



SPECIFICATIONS	175	205	235
Cutting Width	5' 9" (1.74m)	6' 8" (2.04m)	7' 8" (2.34m)
Overall Width	6' 8" (2.04m)	7' 8" (2.34m)	8' 8" (2.66m)
Overall Length	3' 5" (1.05m)	3' 5" (1.05m)	3' 5" (1.05m)
Overall Height	1' 10" (0.55m)	1' 10" (0.55m)	1' 10" (0.55m)
Cut Height Range	0 - 2 3/4" (0 - 70mm)	0 - 2 3/4" (0 - 70mm)	0 - 2 3/4" (0 - 70mm)
Approx. Weight	1520lbs (690kg)	1650lbs (750kg)	1780lbs (810kg)
Total Belts	4	4	4
No. of Flails	24	28	32
Min PTO Output	40hp	44hp	49hp

*Minimum PTO output is a guide only. Requirement varies with the type of work and the terrain



We own two Warlords. No other machine has been heavy enough for what we put them through. The durability of the machine is great - what we ask of it is hard and it does it superbly.

- BRANDON CHAMBLEY | Patten Seed Sod, Atlanta

KEY APPLICATIONS.

- ✓ Orchards & Vineyards
- ✓ Horticulture
- ✓ Municipalities
- ✓ Turf Farms
- ✓ Racecourses
- ✓ Sports Fields
- ✓ Schools
- ✓ Aviation

WHAT'S NEW ON WARLORD S3

The hydraulic side shift and discharge control capabilities are new from the previous Warlord series, further increasing the versatility of the machine.

PRODUCT FEATURES.



HYDRAULIC SIDE SHIFT

The Warlord can be quickly offset to the left or right by up to 19". Perfect for transport and maneuvering around obstacles while mowing.



DISCHARGE CONTROL

Fine mulch is produced with the flap in the lowest position. Controlling discharge assists with safety in public spaces. Lift flap open for easy flail servicing.



PRUNING GUIDE

Helps direct prunings in and under the mower. Also helps keep debris away from the hydraulic system.



REPLACEABLE INTERNAL LINER

A bolt-in 1/4" replaceable internal liner increases the life of the body, minimizes damage and reduces noise.

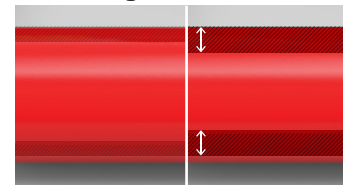

HEAVY DUTY ROLLER

A robust roller with 8.5mm thick walls to handle tough applications.



REPLACEABLE SKIDS

Skids on Warlord trailing arms prolong mower life in demanding terrain and can be replaced when required.

WARLORD OFFSET DIAGRAM

HYDRAULIC SIDE SHIFT / LEFT-HAND OFFSETS AVAILABLE

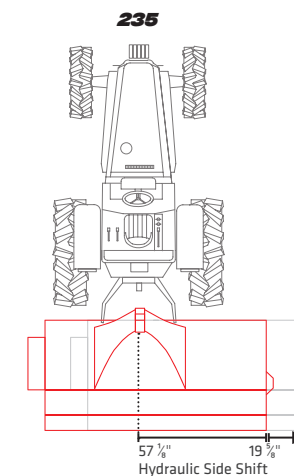
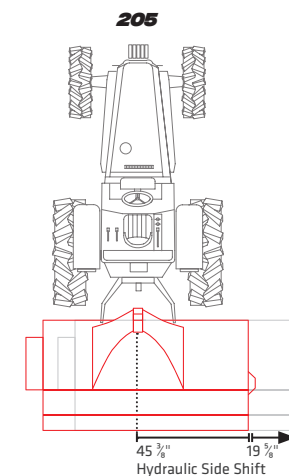
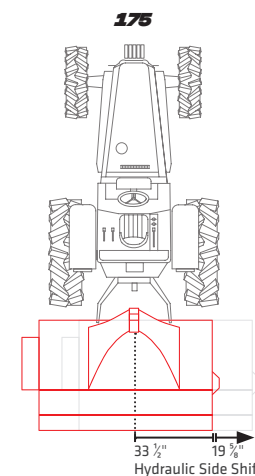

INDUSTRY LEADING WARRANTY

3
YEAR

INCLUDES SPINDLES & GEARBOXES
EXPERIENCED SERVICE & SUPPORT NETWORK

*OPTIONAL FEATURES.

- ✓ **ROLLER SCRAPERS**
Cleans rollers and reduces clumping in wet conditions.
- ✓ **LEFT-HAND OFFSET**
Warlord comes standard in right hand offset, but can be configured with left-hand offset. Suitable for contractors who may prefer visibility over their left hand shoulder.

TALK TO US TODAY ABOUT THE CAPABILITIES OF WARLORD SERIES 3 IN YOUR ENVIRONMENT.

VIEW MORE PHOTOS, VIDEOS, AND INFORMATION ABOUT THE TRIMAX WARLORD SERIES 3 ONLINE HERE:



WANT TO KNOW MORE?
**FIND US
ONLINE.**

**THE TRIMAX
WEBSITE.**

The Trimax website contains more information, photos, and videos of our products and features.

TRIMAXMOWERS.COM



OR USE THIS
QR CODE

**THE TRIMAX
WEB SHOP.**

Easily accessed from the main website, the **Trimax Web Shop** provides everything you need to easily service and maintain your Trimax mower. Best of all, it's **completely free.**

**WITH YOUR TRIMAX WEB
SHOP ACCOUNT, YOU CAN:**

- ✓ Watch step-by-step service and setup videos.
- ✓ Download maintenance checklists.
- ✓ Access the operator manual and parts manual for your mower.
- ✓ Read instructions for installing Trimax Genuine Spare Parts.
- ✓ Register warranty or file a claim.
- ✓ Order Trimax Genuine Parts and Service Kits
- ✓ Review past orders.
- ✓ Upload bulk orders for quick and easy fleet maintenance.
- ✓ Quickly find common parts.
- ✓ Now with improved search functionality - find exactly the part you need.

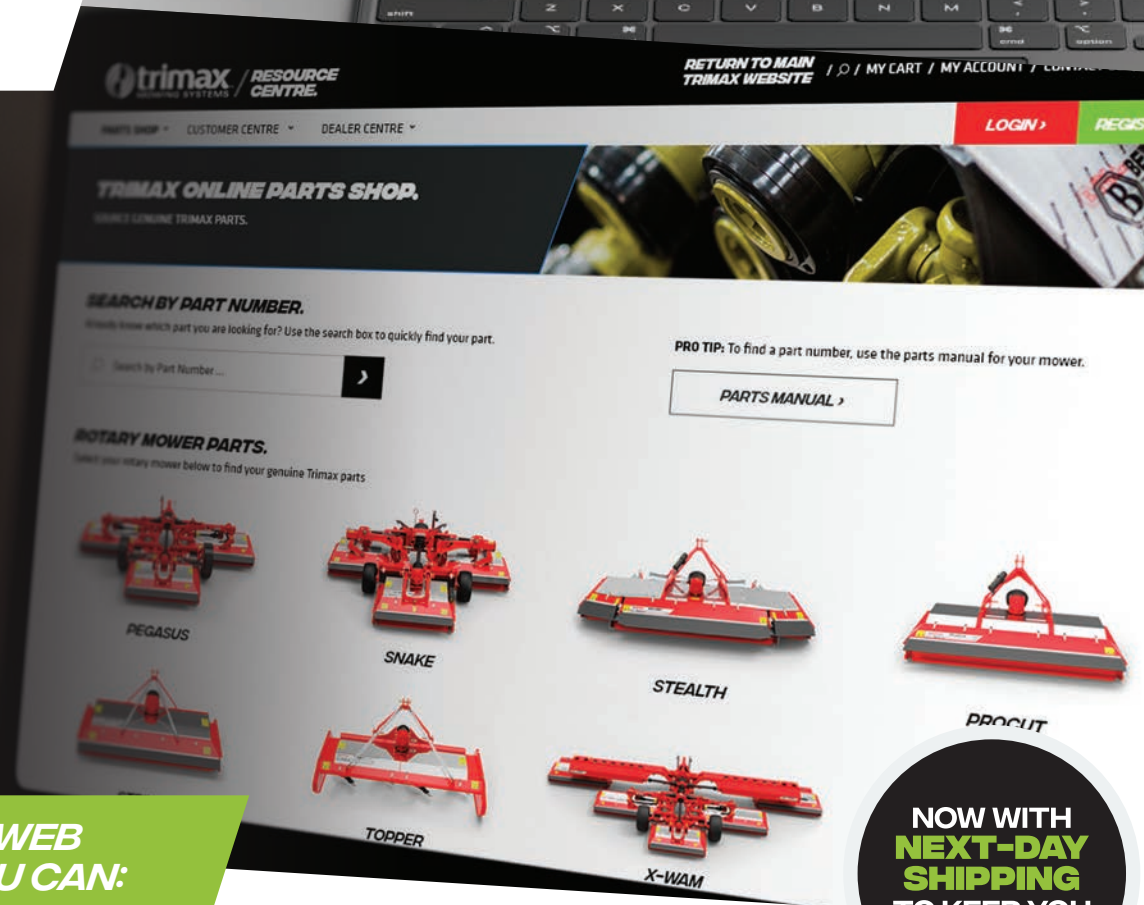
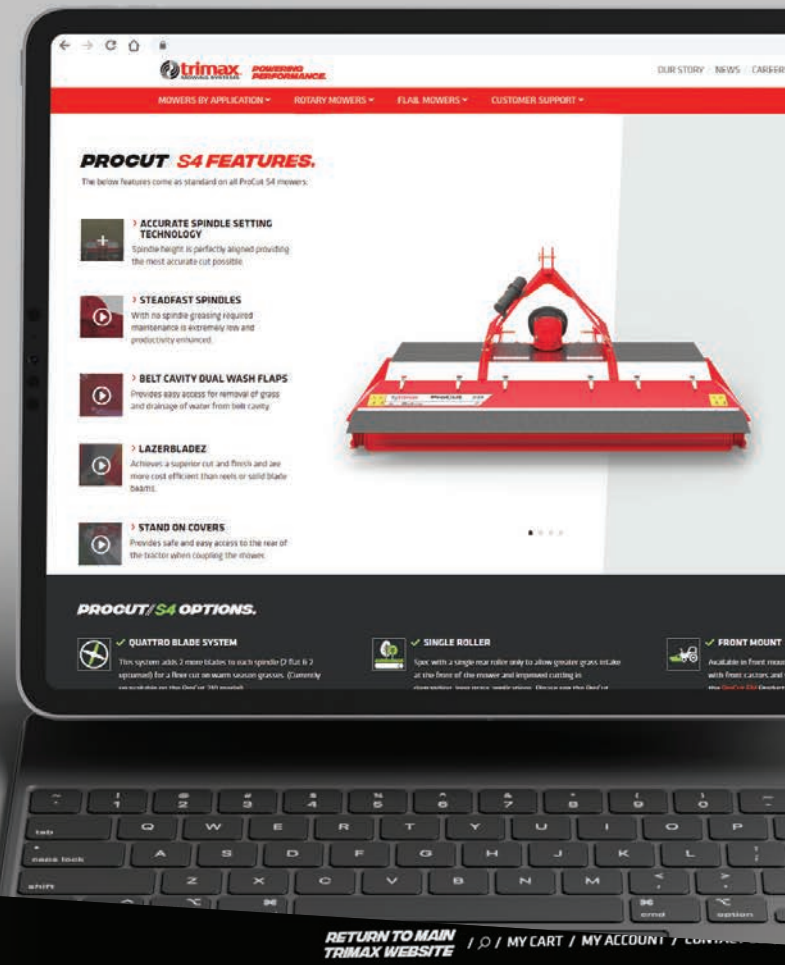

**NOW WITH
NEXT-DAY
SHIPPING
TO KEEP YOU
MOWING!**

PASSIONATE ABOUT
**POWERING YOUR
PERFORMANCE.**



**INDUSTRY-LEADING
3-YEAR WARRANTY.**



**WHEN DOWNTIME IS NOT
AN OPTION, SAVE MONEY
ON EQUIPMENT THAT
LASTS. YOU CAN COUNT
ON TRIMAX.**

**LOW TOTAL
COST OF OWNERSHIP.**

- Long commercial life, with mowers 35 years old and counting still in the field.
- Reduced time, labor, and fuel requirements for each job.
- Affordable aftermarket parts guaranteed to meet Trimax quality standards.

**RELIABLE
SUPPORT.**

- Next-day parts dispatch from our local warehouse in Georgia.
- Knowledgeable local service staff and easy-to-access online resources.
- Industry-leading 3-year warranty which includes spindles and gearboxes.

**PRODUCTIVITY-BOOSTING
EFFICIENCY.**

- Less time in the shop with minimised and simplified service requirements.
- Designed for/tested in the harshest environments for maximum uptime in normal commercial operations.
- A wide range of available options to customise for your specific needs.

**TRIMAX BUILDS MOWERS
THAT LAST, AND WE BACK
THAT UP BY OFFERING
THE LONGEST AND
MOST COMPREHENSIVE
WARRANTY IN THE
INDUSTRY.**

All Trimax mowers come with a standard 12-month warranty with the opportunity to extend **another 24 months** by registering new machines online.

- ✓ **COVERS SPINDLES**
- ✓ **COVERS GEARBOXES**
- ✓ **ABSOLUTELY FREE**



DISTRIBUTED FROM OUR
USA
WAREHOUSE

TRIMAX MOWING SYSTEMS

310 Etowah Trace, Fayetteville, GA 30214

P +1 770 412 8402 / **E** info@trimaxmowers.com

FOR MOWER SALES

P +1 770 412 8402 / **E** info@trimaxmowers.com

FOR PARTS ORDERS

P +1 770 412 8402 / **E** parts@trimaxmowers.com



 **trimax**[™] // **POWERING PERFORMANCE.**
MOWING SYSTEMS

      // **TRIMAXMOWERS.COM**